

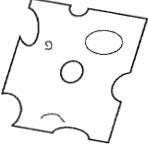







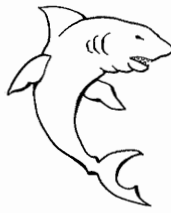
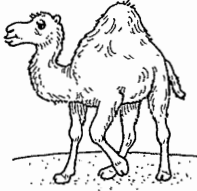

General Assessment

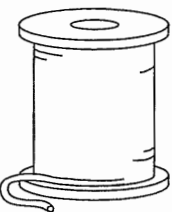
Circle the missing letter or letters. Write the letter or letters to complete the word.

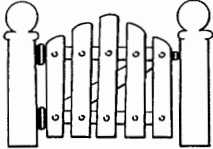
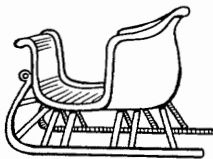
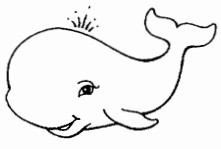
<p>1.</p>  <p>g gu gh</p> <p>____itar</p>	<p>2.</p>  <p>sh ch c</p> <p>____eese</p>	<p>3.</p>  <p>ew ui oo</p> <p>s____t</p>
<p>4.</p>  <p>ar er or</p> <p>sh____k</p>	<p>5.</p>  <p>e u o</p> <p>cam____l</p>	<p>6.</p>  <p>g j i</p> <p>____erbil</p>
<p>7.</p>  <p>thr shr spr</p> <p>____ead</p>	<p>8.</p>  <p>eer ear our</p> <p>b____</p>	<p>9.</p>  <p>c s ch</p> <p>____ity</p>
<p>10.</p>  <p>ay a ai</p> <p>g____te</p>	<p>11.</p>  <p>ei ea ay</p> <p>sl____gh</p>	<p>12.</p>  <p>ch wh sh</p> <p>____ale</p>
<p>13.</p>  <p>ou al ie</p> <p>ch____k</p>	<p>14.</p>  <p>oi oy ou</p> <p>b____</p>	<p>15.</p>  <p>sh k ch</p> <p>____oir</p>

General Assessment, p. 2

Fill in the circle next to the word that completes each sentence.

1. I woke up Friday morning with a sore _____.
 throw through
 throat three

2. Then I started to _____ a lot.
 cuff cough
 catch coast

3. I grabbed a _____ each time I sneezed.
 tickle tassel
 turtle tissue

4. I really wanted to go to _____ today.
 spring school
 scheme stretch

5. I had to give a book _____.
 report ready
 reach round

6. Dad said I needed to stay home because I was _____.
 sung sick
 sent sand

7. He was worried that I would spread the _____ to my friends.
 gas giant
 germs goat

8. He _____ my teacher.
 telephoned photographed
 elephant autographed

9. I snuggled in bed under my favorite _____.
 bucket border
 basket blanket

10. I planned to spend the day reading lots of _____.
 briefs books
 boils bowls

11. Before long, my eyes were feeling _____.
 hairy howling
 hoist heavy

12. I _____ the rest of the day.
 slept stood
 stepped sleigh

Short Vowels

If a word has only one vowel, the vowel sound is usually short.



cat

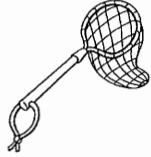

net



fish



fox





cup

Write the letter for the vowel sound in each picture name.

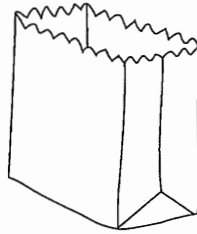
1. 

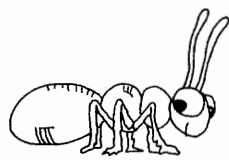
2. 

3. 

4. 

5. 

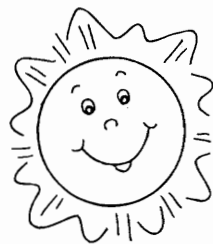
6. 

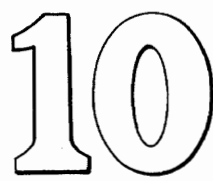
7. 

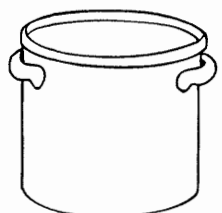
8. 

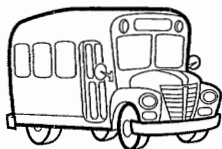
9. 

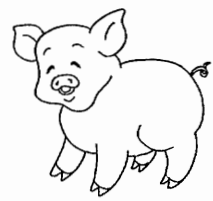
10. 

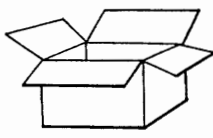
11. 

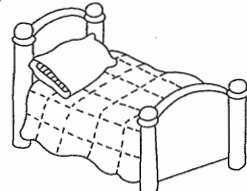
12. 

Short Vowels in Context

Circle the word that completes the sentence. Write the word on the line.



- | | | | |
|---|--------|-------|--------|
| 1. When I wake up, I see the _____. | set | sun | sit |
| 2. On Saturday morning, I _____ in the garden. | help | heap | hello |
| 3. I wear a _____ to keep the sun off my head. | heat | hen | hat |
| 4. I take care of all my _____. | please | plugs | plants |
| 5. I _____ my bucket with water. | five | fill | fall |
| 6. I water the plants and _____ out the weeds. | dig | drip | deep |
| 7. About noon, it starts to get _____. | hot | hill | hit |
| 8. I stop for a rest and sit on a _____. | pinch | bench | bean |
| 9. I watch a lizard jump on a _____. | rock | road | rack |
| 10. I see a black _____ crawl by. | big | bug | bag |
| 11. I wish a little frog would _____ by, too. | hog | hop | hope |
| 12. The morning is at an _____. | elf | mend | end |
| 13. I'll go in and eat my _____ now. | lunch | lamp | lurch |
| 14. This is the _____ way to spend time in the sun. | bus | best | beet |

Long Vowels a_e, i_e, and o_e

A vowel usually has the long sound when a consonant and e come after it. The e is silent.



rake

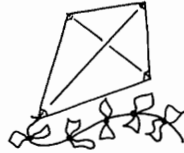

kite



smoke

Write each picture name on the line.

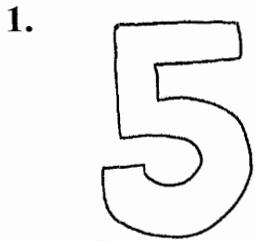

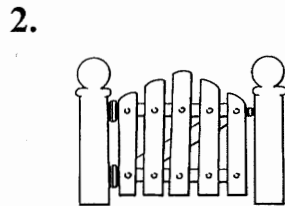

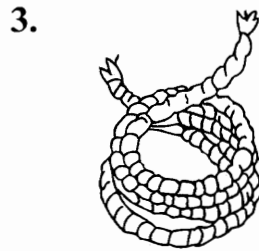

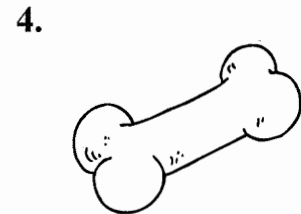









Write the vowel that completes each sentence.

9. T__ke the c__ke to the l__ke.
10. A long p__le would not reach the m__le in that h__le.
11. A l__me costs a d__me all the t__me.

Long Vowels a_e, i_e, and o_e in Context

Complete each sentence with a word from the box.

nice	home
gate	drives
wake	whole
time	five
late	make
mile	ride
robe	take

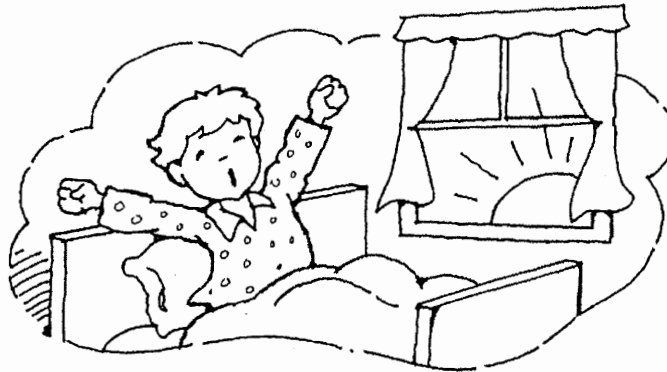

1. Each morning, I try to _____ up at the same time.
2. I don't like to be _____ for school.
3. In fact, I pride myself on being on _____.
4. It takes me _____ minutes to wake up.
5. I eat my breakfast in my _____.
6. Sometimes I drink a _____ carton of milk.
7. Then I _____ a quick bath.
8. After I'm dressed, I _____ my bed.
9. Then I pack a _____ healthy lunch.
10. Now I am ready to leave _____.
11. On some days, I walk a _____ to school.
12. On other days, I get a _____ with my neighbor.
13. I walk out and stand by the _____ in front of my house.
14. My neighbor stops when she _____ by.